

LEDGESTONE U BAR ASSEMBLY GUIDE

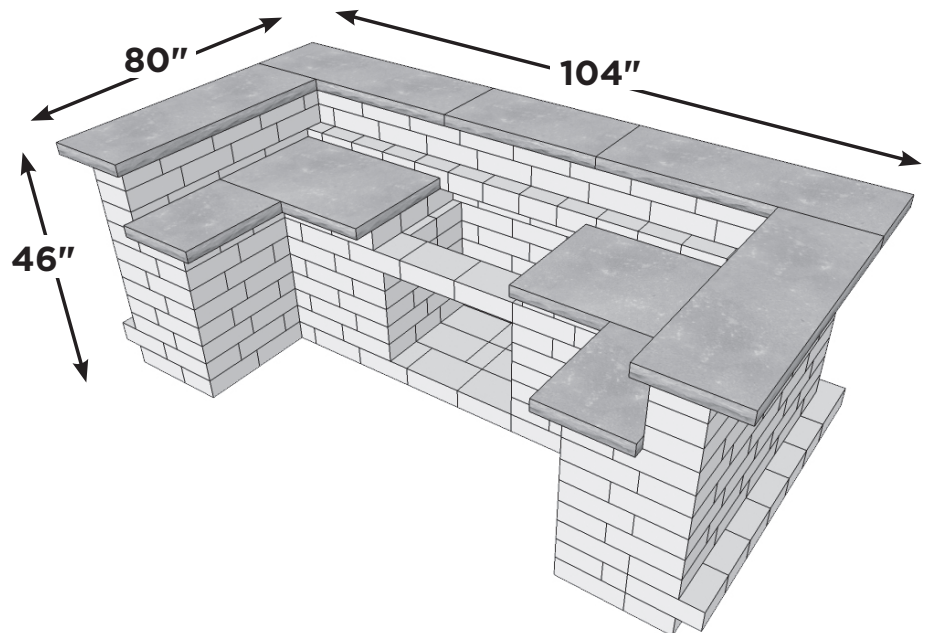

Finished Size



- **Easy to Follow Assembly Instructions**
- **Maintenance Free**
- **Minimal Cuts Required**
- **Frost Footings Optional**

A LedgeStone U bar kit is the perfect outdoor feature for anyone who loves to entertain. These kits are extra easy to assemble. Just stack and glue the LedgeStone units and top off with the natural stone countertops. Minimal cuts are required.

Material List	
Kit Quantities include extra material to accommodate cuts.	
Ledgestone Units 8"(w) x 4"(h) x 12"(d)	
Kit Quantity = 360	Pieces Used
Full Units	342
Cut to 4"(w) x 8"(d)	2
Cut to 4"(w) x 12"(d)	3
Cut to 8"(w) x 8"(d)	4
TOTAL	351
Bedford Countertops	
(Kit Quantity = 5)	Pieces Used
48"(w) x 2 1/4"(h) x 16"(d)	6
36"(w) x 2 1/4"(h) x 24"(d)	2
Other Materials	
Adhesive	24

The information, including technical data, figures, tables, designs, drawings, details, suggested procedures and suggested specifications, presented in this publication is for general information only. While every effort has been made to ensure its accuracy, this information should not be used or relied upon for any application without verification of accuracy, suitability, and applicability for the use contemplated, which is the sole responsibility of the user. A final, project-specific design should be prepared by a qualified, licensed, professional based on actual site conditions. Willow Creek Concrete Products disclaims any and all express or implied warranties of merchantability fitness for any general or particular purpose, trademark or copyright in regard to information or products contained or referred to herein.

This assembly guide is intended for use only with the Ledgestone Two Tier Bar Kit. Use with substitute products is strictly prohibited without prior written approval from Willow Creek Paving Stones.

Before You Begin:

Before you plan your project, be sure to find out about zoning requirements in your area, along with rules for excavating and building. Whether your project is large or small, you should obtain all required permits before you begin your project.

Call 811 before you dig. Every digging job requires a call—even small projects like planting trees and shrubs. The depth of utility lines varies and there may be multiple utility lines in a common area. Digging without calling can disrupt service to an entire neighborhood, harm you and those around you and potentially result in fines and repair costs. Calling 811, a federally mandated call-before-you-dig number, before every digging job gets your underground utility lines marked for FREE and helps prevent undesired consequences.

All contents copyright ©2016 Willow Creek Concrete Products



**Know what's below.
Call before you dig.**

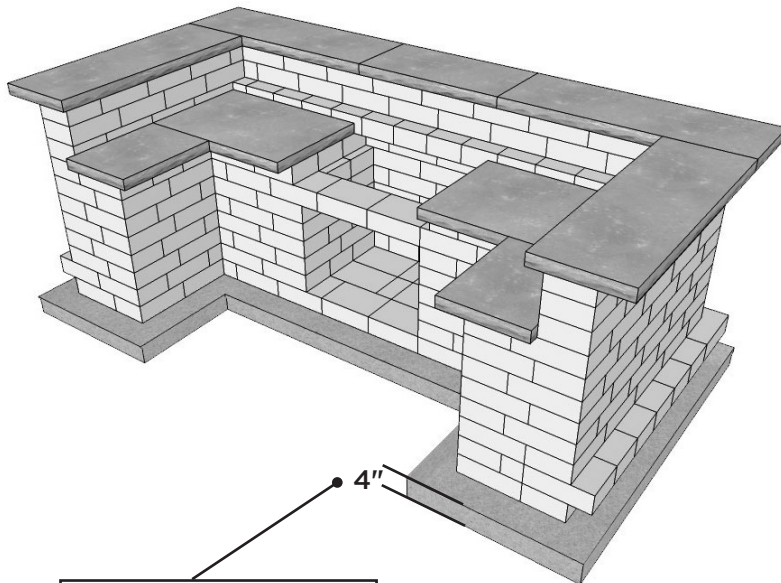

**POURED CONCRETE
FOUNDATION**

*MIN 4" (DEPTH) & REINFORCED
WITH #3 REBAR.

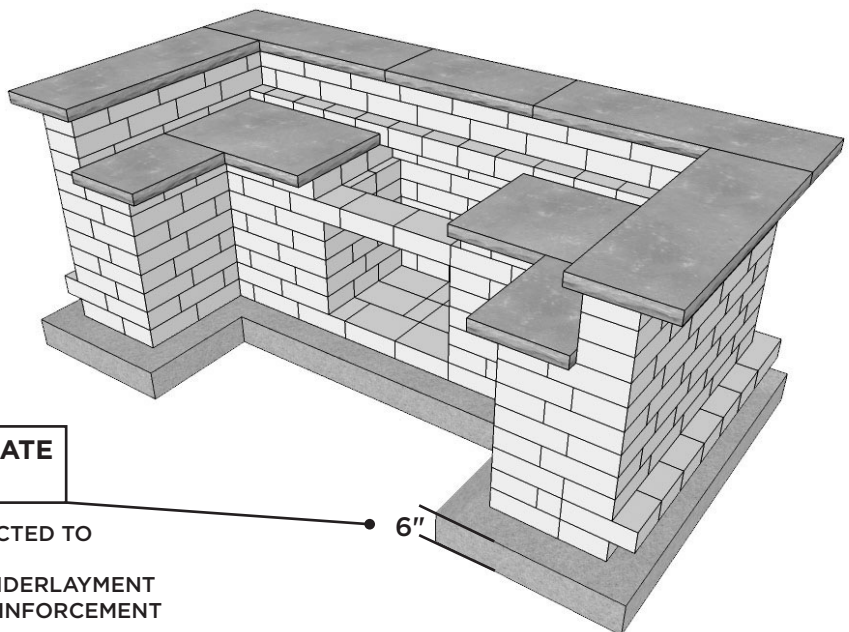

**CRUSHED AGGREGATE
FOUNDATION**

*MIN 6" (DEPTH) COMPACTED TO
95% PROCTOR
*USE WILLOW CREEK UNDERLAYMENT
FABRIC FOR ADDED REINFORCEMENT

STEP 1

46: FULL LEDGESTONE™ UNITS
2 LEDGESTONE™ UNITS CUT TO 4"(w) x 8" (d)

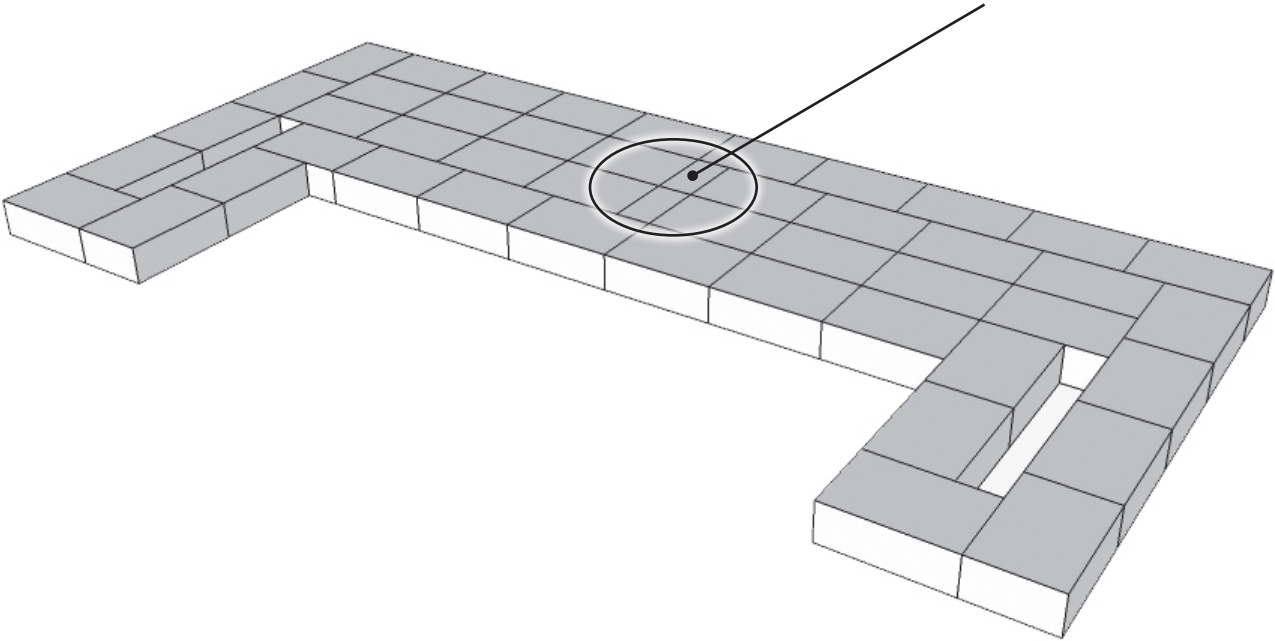

STEP 2

42: FULL LEDGESTONE™ UNITS
2 LEDGESTONE™ UNITS CUT TO 4"(w) x 12" (d)

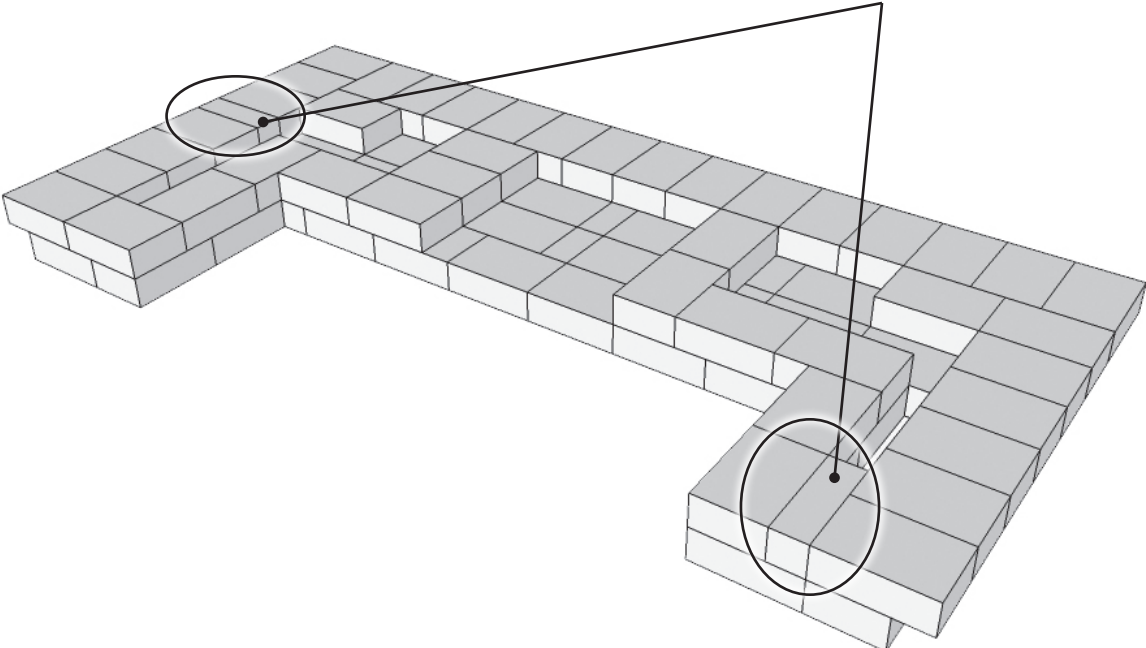

STEP 3

33: FULL LEDGESTONE™ UNITS

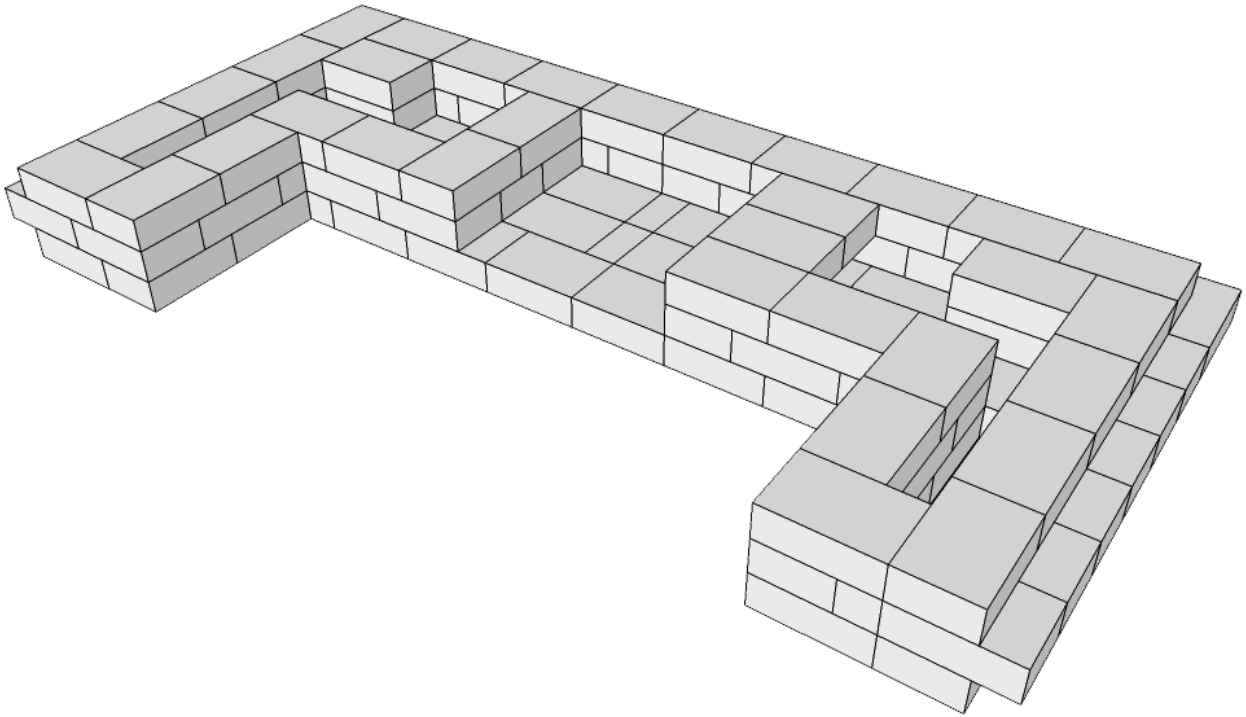

STEP 4

33: FULL LEDGESTONE™ UNITS

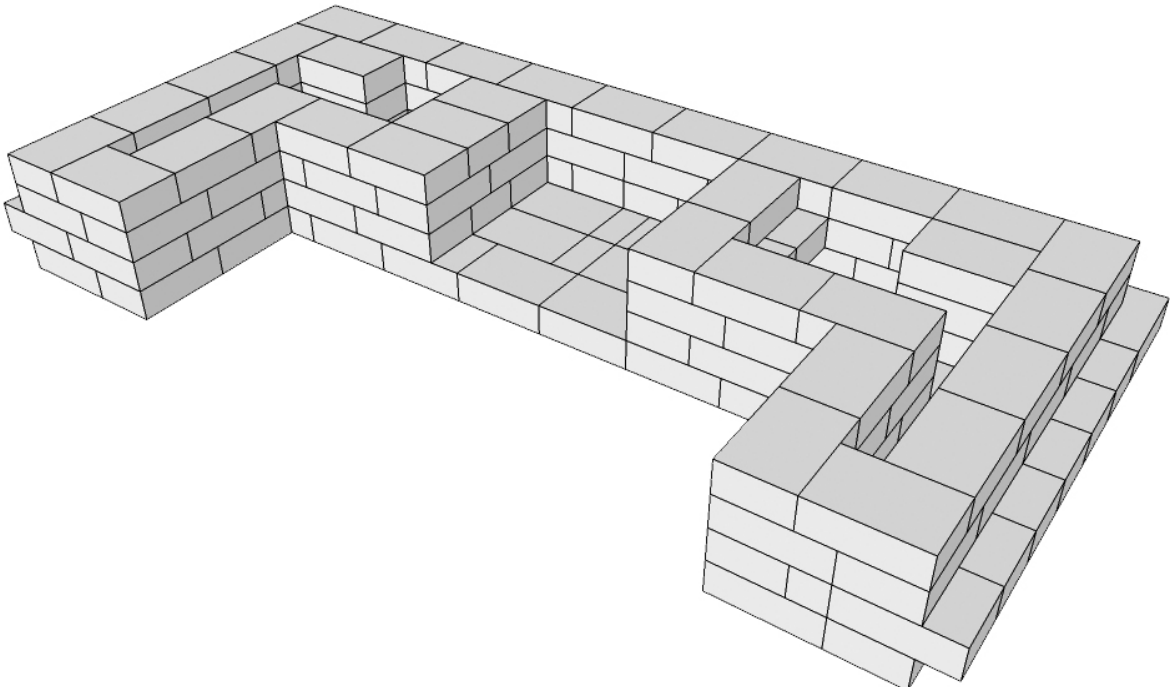

STEP 5

33: FULL LEDGESTONE™ UNITS

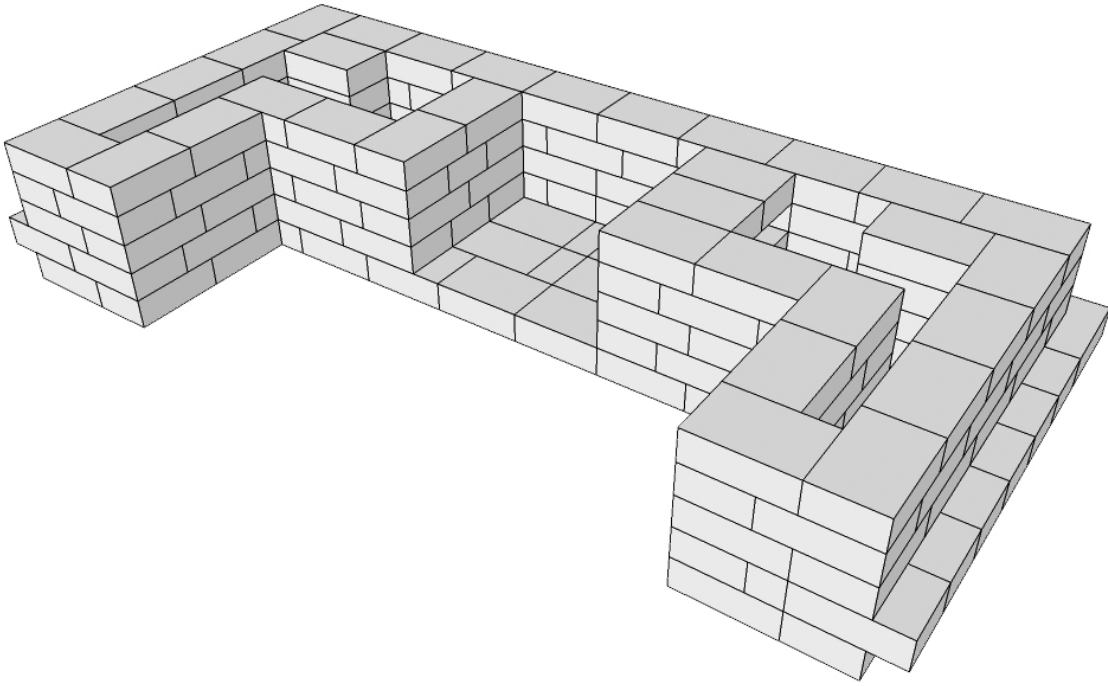

STEP 6

**33: FULL LEDGESTONE™ UNITS
INSTALL STEEL SUPPORT**

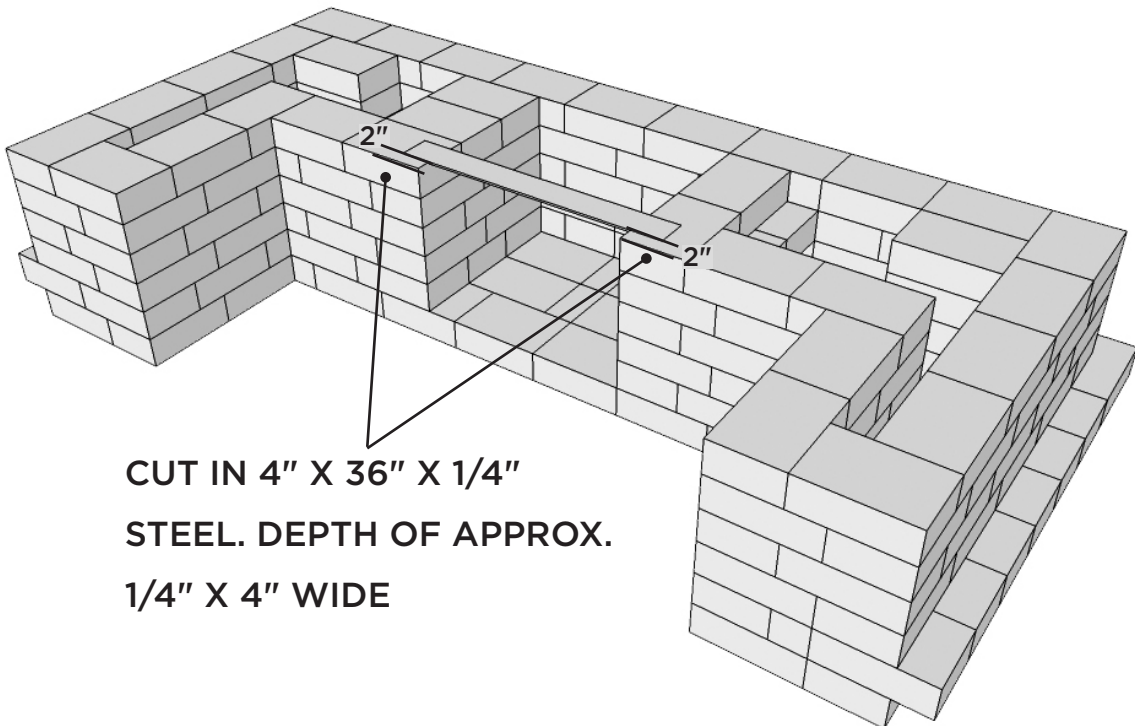

STEP 7

36: FULL LEDGESTONE™ UNITS

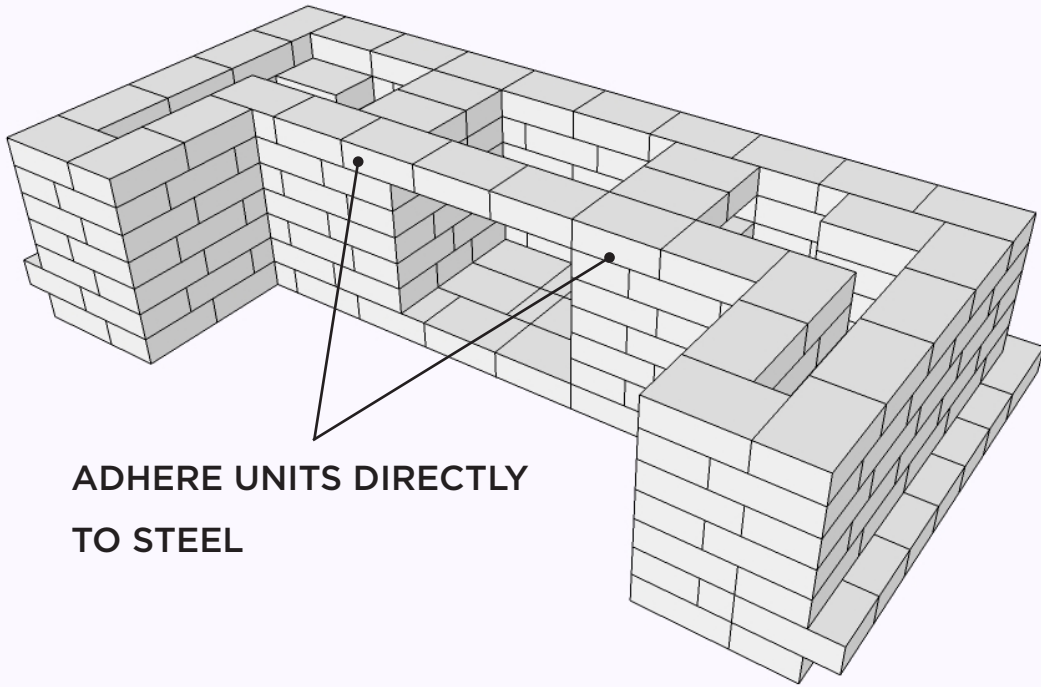

**ADHERE UNITS DIRECTLY
TO STEEL**

STEP 8

**32: FULL LEDGESTONE™ UNITS
2 LEDGESTONE™ UNITS CUT TO FIT GRILL**

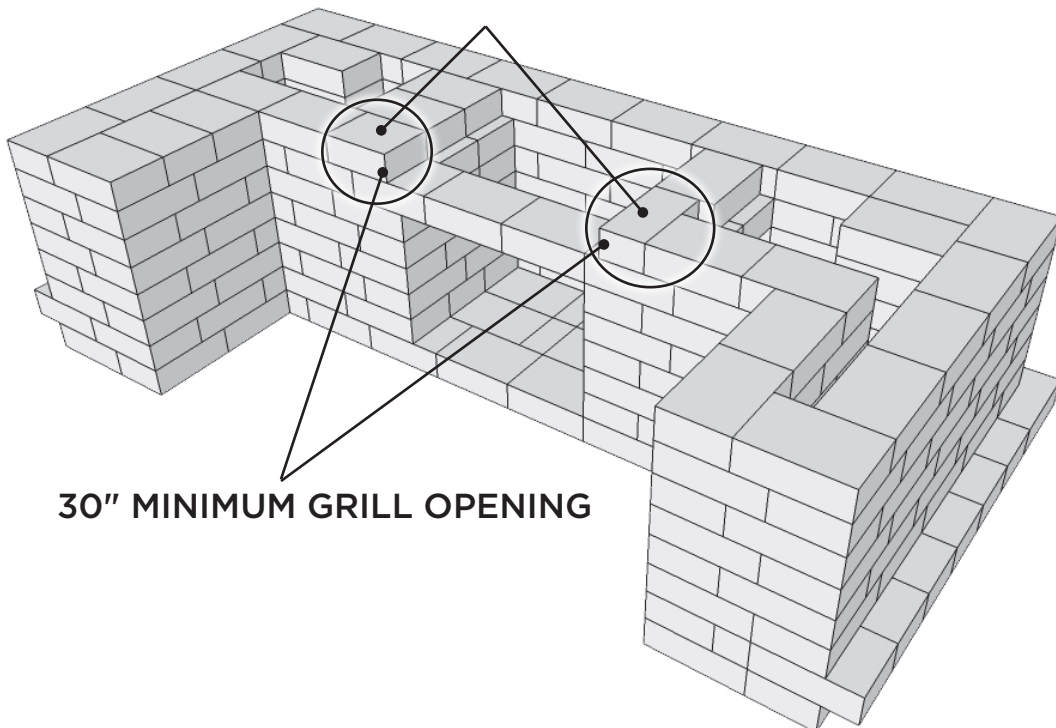

30" MINIMUM GRILL OPENING

STEP 9

20: FULL LEDGESTONE™ UNITS

2 LEDGESTONE™ UNIT CUT TO 8"(w) x 8" (d)

1 LEDGESTONE™ UNIT CUT TO 4"(w) x 12" (d)

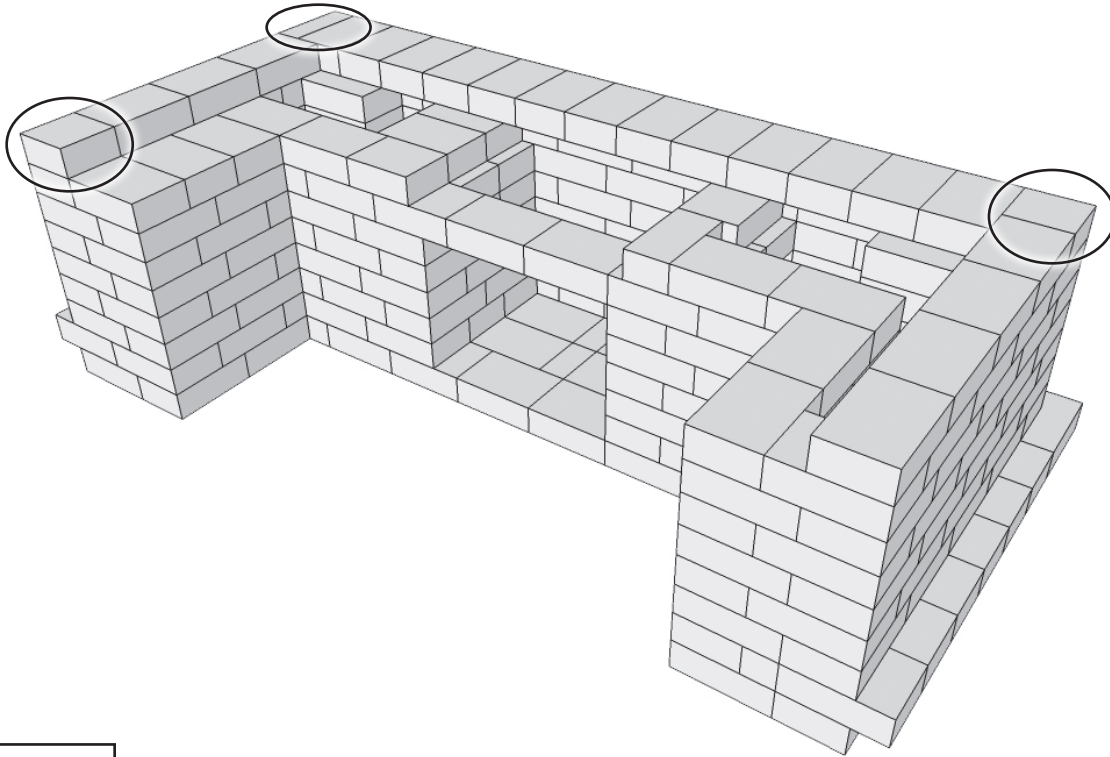

STEP 10

17: FULL LEDGESTONE™ UNITS

1 LEDGESTONE™ UNIT CUT TO 8"(w) x 8" (d)

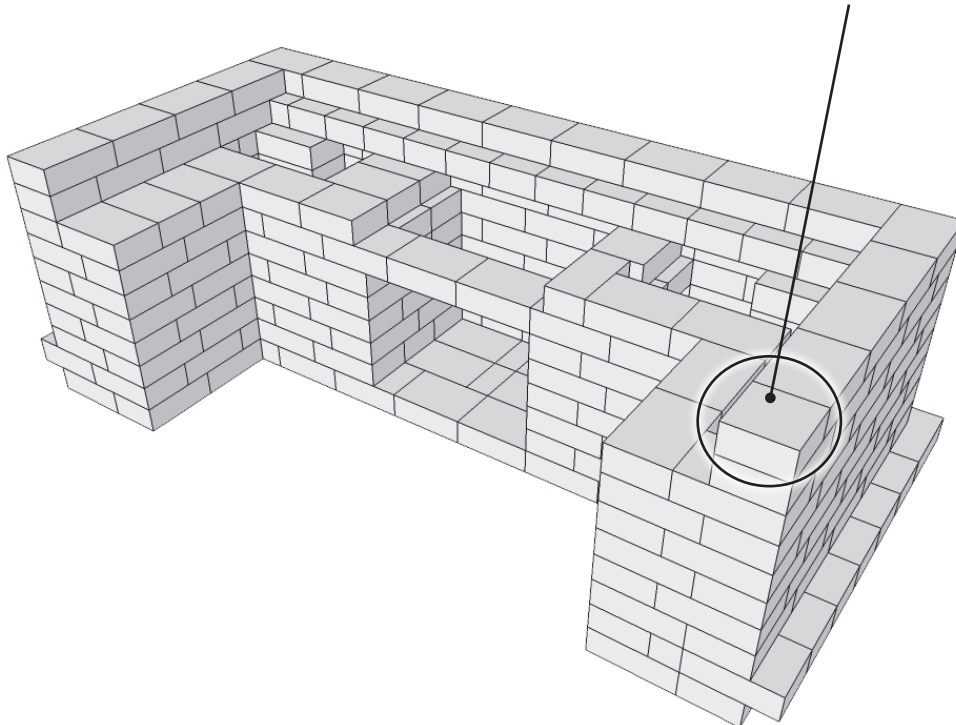

STEP 11

**17: FULL LEDGESTONE™ UNITS
1 LEDGESTONE™ UNIT CUT TO 8"(w) x 8" (d)**

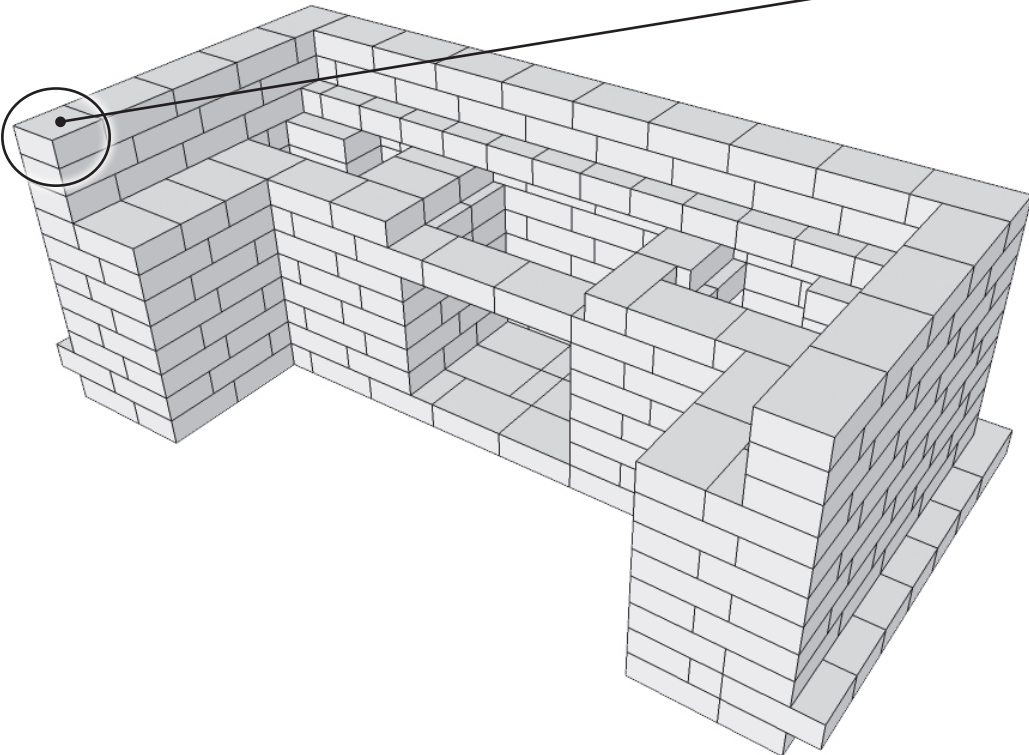

STEP 12

TRIM COUNTER TOPS TO FIT

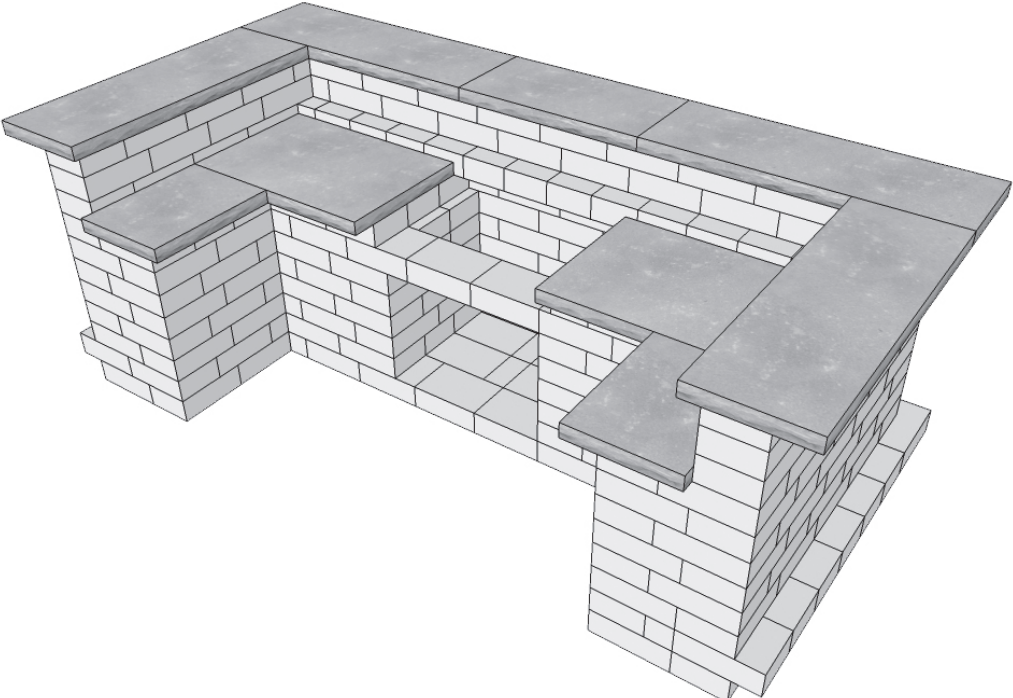

STEP 13



INSTALL NAPOLEON GRILL BRACKETS ON TOP OF COUNTER TOPS (OPPOSITE OF MANUFACTURER'S INSTRUCTIONS) TO ACCOMMODATE GRILL HEIGHT.

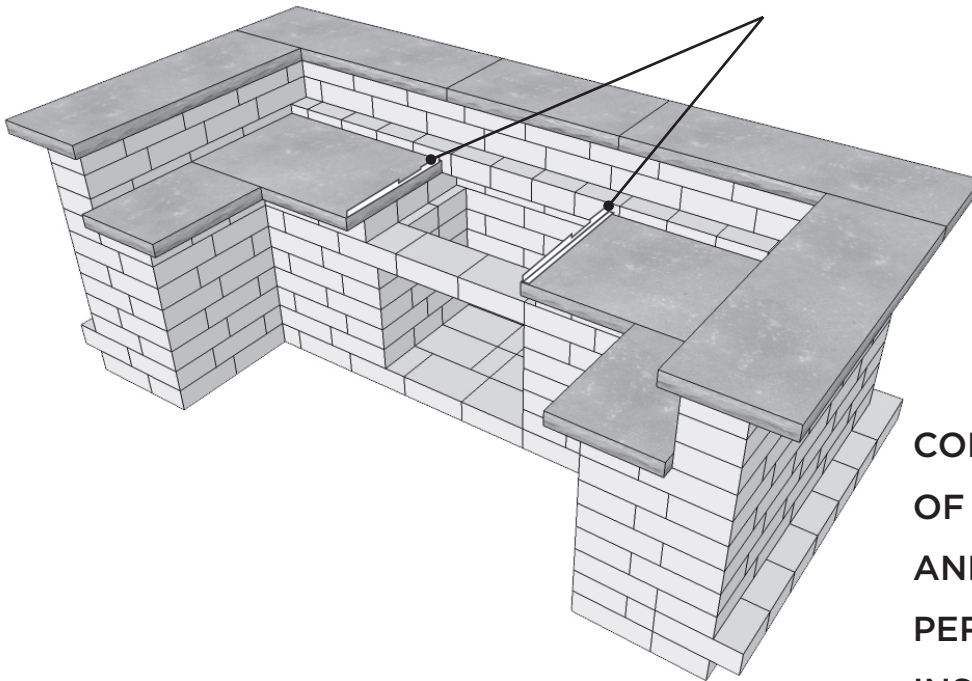

CONTINUE INSTALLATION OF NAPOLEON GRILL AND STEEL DOORS PER MANUFACTURER'S INSTRUCTIONS.

PG.9

WillowCreek™
Paving Stones